

MS MAASDAM

DECK PLANS & STATEROOMS

The deck plans are color-coded by category of stateroom, and the category letter precedes the stateroom number in each room. All staterooms are equipped with flat-panel television, DVD player, telephone and multichannel music.

Important Note: Not all staterooms within each category have the same furniture configuration and/or facilities. Appropriate symbols within the rooms on the deck plans describe differences from the stateroom descriptions below.

All information is subject to change.

STATEROOM SYMBOL LEGEND

- Triple (2 lower beds, 1 sofa bed)
- Quad (2 lower beds, 1 sofa bed, 1 upper)
- △ Partial sea view
- × Fully obstructed view
- + Connecting rooms
- ◇ These staterooms have portholes instead of windows
- ★ Suites SA030, B200 & B202 and staterooms K500, G501, G502, C563, FF829 & FF831 are modified accessible, shower only with small step, step into bathroom, standard interior and exterior door size
- ♿ Staterooms CA367, EE389, EE390, G704, G706, G709 & G711 are wheelchair accessible, roll-in shower only, wheelchair-accessible doorways

OCEAN-VIEW STATEROOMS

D E F FF

Large: 2 lower beds convertible to 1 queen-size bed, bathtub & shower.
Approximately 174–255 sq. ft.

G

Large: 2 lower beds convertible to 1 queen-size bed, bathtub & shower. All G-category staterooms have portholes.
Approximately 174–255 sq. ft.

INTERIOR STATEROOMS

J MM N

Large: 2 lower beds convertible to 1 queen-size bed, shower.
Approximately 141–226 sq. ft.

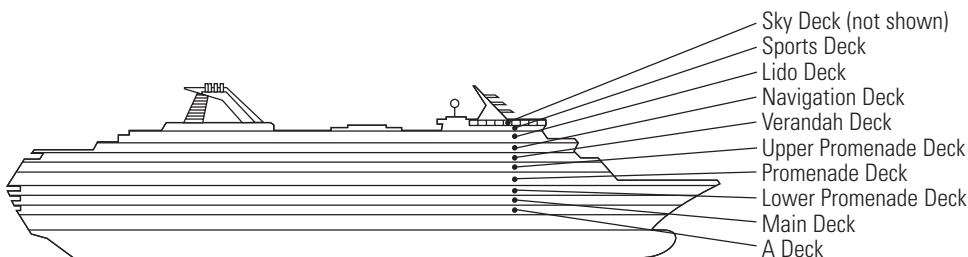

DECK 4—A DECK

Staterooms 700–848

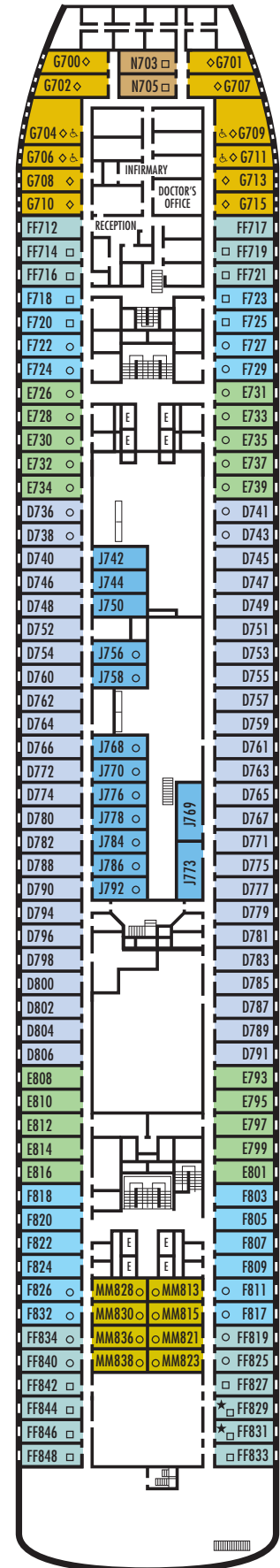

MS MAASDAM

DECK PLANS & STATEROOMS

The deck plans are color-coded by category of stateroom, and the category letter precedes the stateroom number in each room. All staterooms are equipped with flat-panel television, DVD player, telephone and multichannel music.

Important Note: Not all staterooms within each category have the same furniture configuration and/or facilities. Appropriate symbols within the rooms on the deck plans describe differences from the stateroom descriptions below.

All information is subject to change.

STATEROOM SYMBOL LEGEND

- Triple (2 lower beds, 1 sofa bed)
- Quad (2 lower beds, 1 sofa bed, 1 upper)
- △ Partial sea view
- × Fully obstructed view
- + Connecting rooms
- ◇ These staterooms have portholes instead of windows
- ★ Suites SA030, B200 & B202 and staterooms K500, G501, G502, C563, FF829 & FF831 are modified accessible, shower only with small step, step into bathroom, standard interior and exterior door size
- ♿ Staterooms CA367, EE389, EE390, G704, G706, G709 & G711 are wheelchair accessible, roll-in shower only, wheelchair-accessible doorways

OCEAN-VIEW STATEROOMS

C **DA** **DD** **E**

Large: 2 lower beds convertible to 1 queen-size bed, bathtub & shower. Approximately 174–255 sq. ft.

G

Large: 2 lower beds convertible to 1 queen-size bed, bathtub & shower. All G-category staterooms have portholes. Approximately 174–255 sq. ft.

INTERIOR STATEROOMS

J **K** **L** **M**

Large: 2 lower beds convertible to 1 queen-size bed, shower. Approximately 141–226 sq. ft.

DECK 5—MAIN DECK

Staterooms 500–698

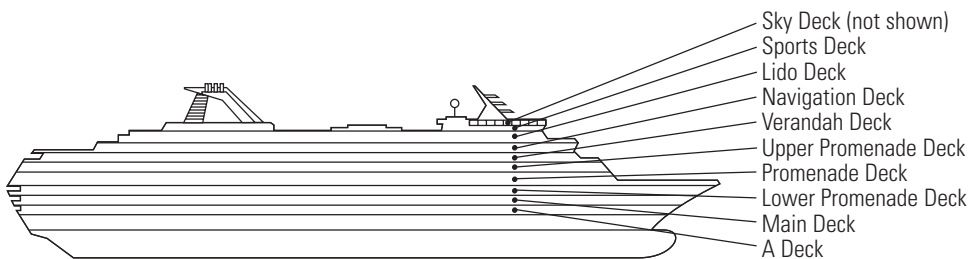
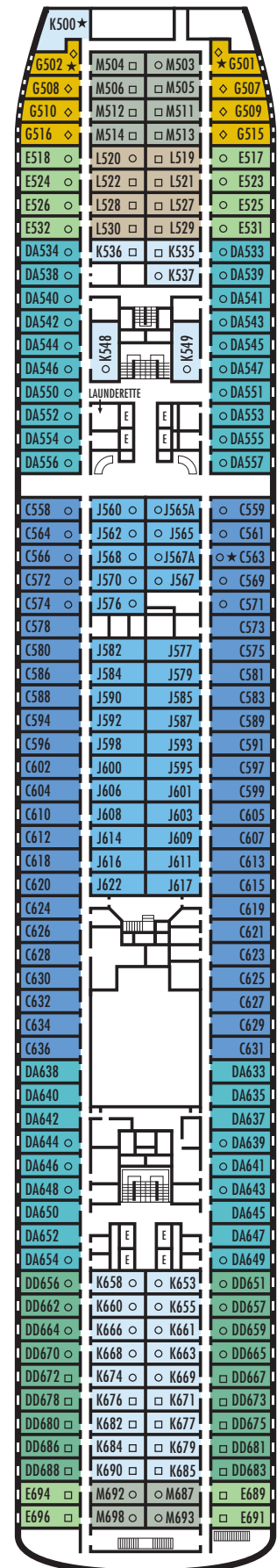

MS MAASDAM

DECK PLANS & STATEROOMS

The deck plans are color-coded by category of stateroom, and the category letter precedes the stateroom number in each room. All staterooms are equipped with flat-panel television, DVD player, telephone and multichannel music.

Important Note: Not all staterooms within each category have the same furniture configuration and/or facilities. Appropriate symbols within the rooms on the deck plans describe differences from the stateroom descriptions below.

All information is subject to change.

STATEROOM SYMBOL LEGEND

- Triple (2 lower beds, 1 sofa bed)
- Quad (2 lower beds, 1 sofa bed, 1 upper)
- △ Partial sea view
- × Fully obstructed view
- + Connecting rooms
- ◇ These staterooms have portholes instead of windows
- ★ Suites SA030, B200 & B202 and staterooms K500, G501, G502, C563, FF829 & FF831 are modified accessible, shower only with small step, step into bathroom, standard interior and exterior door size
- ♿ Staterooms CA367, EE389, EE390, G704, G706, G709 & G711 are wheelchair accessible, roll-in shower only, wheelchair-accessible doorways

OCEAN-VIEW STATEROOMS

CA

Lanai: 2 lower beds convertible to 1 queen-size bed, bathtub & shower. Sliding glass doors lead onto the walk-around Lower Promenade Deck. Approximately 181–256 sq. ft.

D E EE

Large: 2 lower beds convertible to 1 queen-size bed, bathtub & shower. Approximately 174–255 sq. ft.

H HH

Large: 2 lower beds convertible to 1 queen-size bed, bathtub & shower. All H-category staterooms have partial sea views. All HH-category staterooms have fully obstructed views. Approximately 174–255 sq. ft.

INTERIOR STATEROOMS

I L

Large: 2 lower beds convertible to 1 queen-size bed, shower. Approximately 141–226 sq. ft.

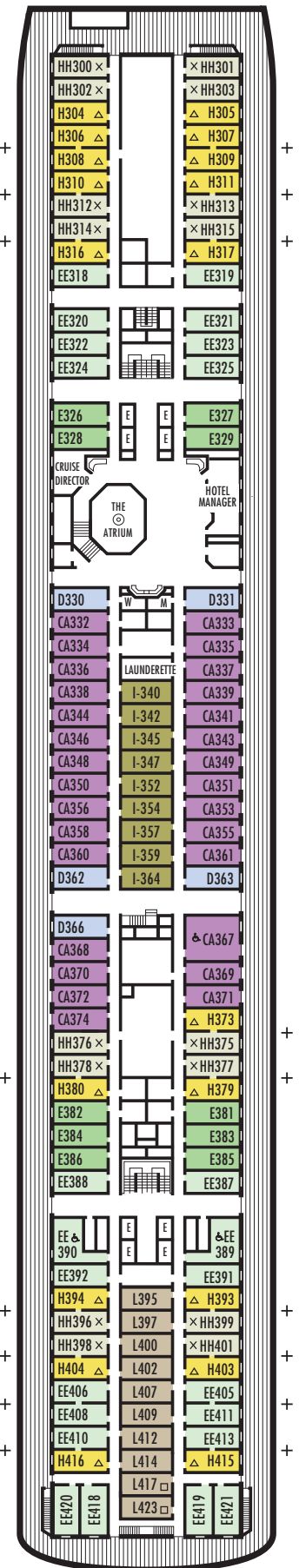
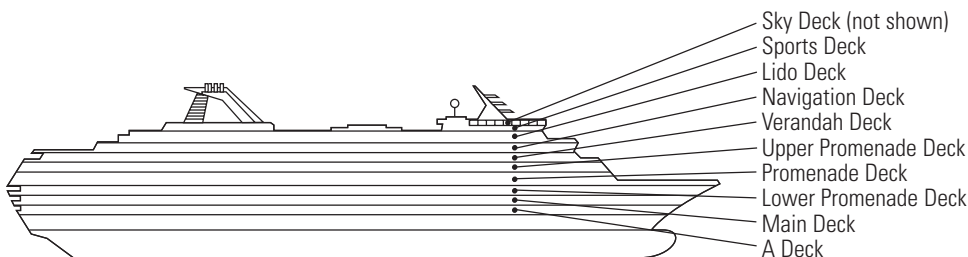

MS MAASDAM

DECK PLANS & STATEROOMS

The deck plans are color-coded by category of stateroom, and the category letter precedes the stateroom number in each room. All staterooms are equipped with flat-panel television, DVD player, telephone and multichannel music.

Important Note: Not all staterooms within each category have the same furniture configuration and/or facilities. Appropriate symbols within the rooms on the deck plans describe differences from the stateroom descriptions below.

All information is subject to change.

STATEROOM SYMBOL LEGEND

- Triple (2 lower beds, 1 sofa bed)
- Quad (2 lower beds, 1 sofa bed, 1 upper)
- △ Partial sea view
- × Fully obstructed view
- + Connecting rooms
- ◇ These staterooms have portholes instead of windows
- ★ Suites SA030, B200 & B202 and staterooms K500, G501, G502, C563, FF829 & FF831 are modified accessible, shower only with small step, step into bathroom, standard interior and exterior door size
- ♿ Staterooms CA367, EE389, EE390, G704, G706, G709 & G711 are wheelchair accessible, roll-in shower only, wheelchair-accessible doorways

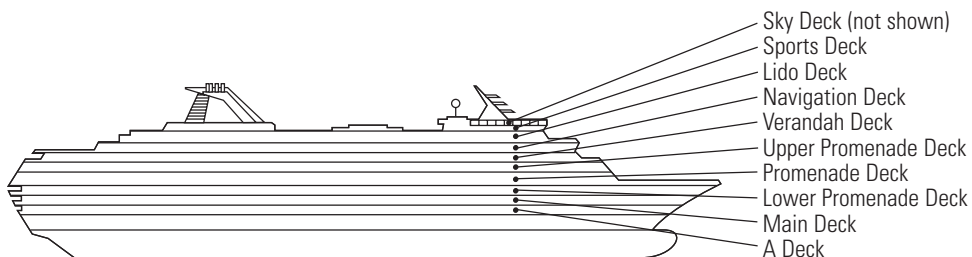

DECK 7—PROMENADE DECK

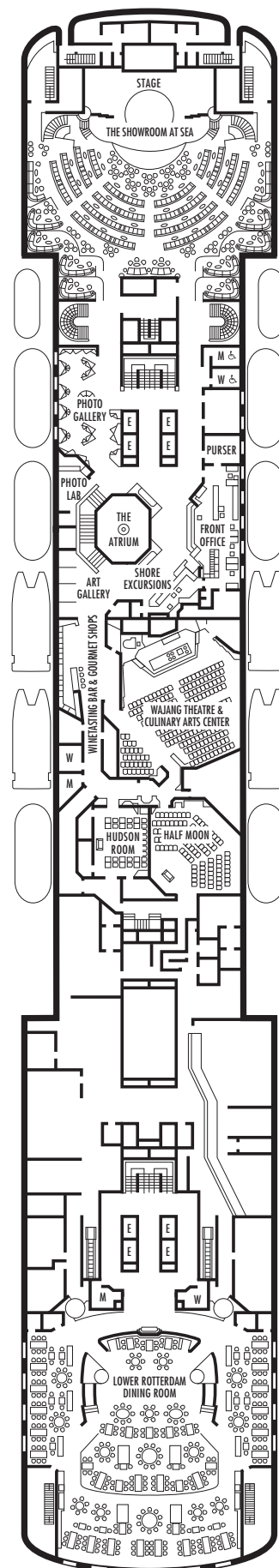

MS MAASDAM

DECK PLANS & STATEROOMS

The deck plans are color-coded by category of stateroom, and the category letter precedes the stateroom number in each room. All staterooms are equipped with flat-panel television, DVD player, telephone and multichannel music.

Important Note: Not all staterooms within each category have the same furniture configuration and/or facilities. Appropriate symbols within the rooms on the deck plans describe differences from the stateroom descriptions below.

All information is subject to change.

STATEROOM SYMBOL LEGEND

- Triple (2 lower beds, 1 sofa bed)
- Quad (2 lower beds, 1 sofa bed, 1 upper)
- △ Partial sea view
- × Fully obstructed view
- + Connecting rooms
- ◇ These staterooms have portholes instead of windows
- ★ Suites SA030, B200 & B202 and staterooms K500, G501, G502, C563, FF829 & FF831 are modified accessible, shower only with small step, step into bathroom, standard interior and exterior door size
- ♿ Staterooms CA367, EE389, EE390, G704, G706, G709 & G711 are wheelchair accessible, roll-in shower only, wheelchair-accessible doorways

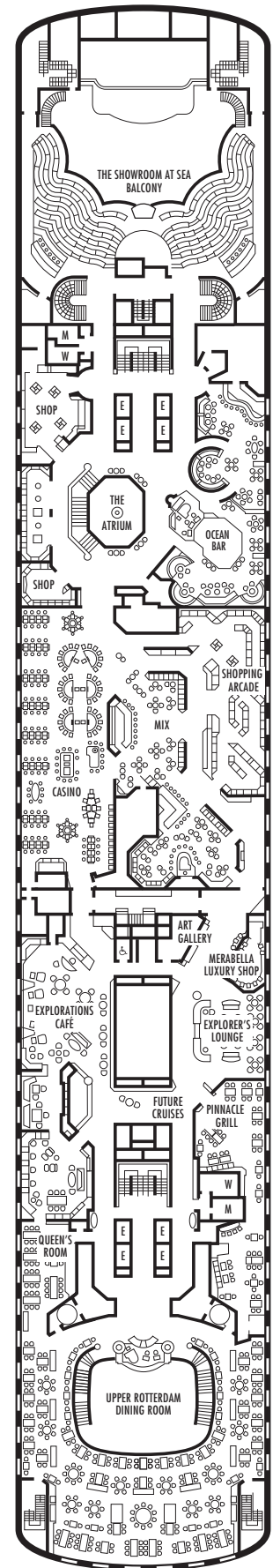
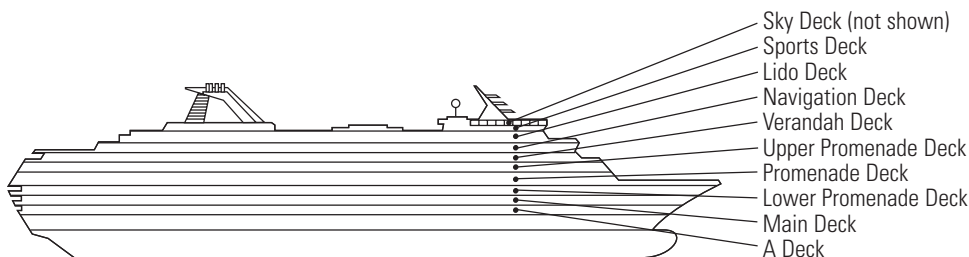

MS MAASDAM

DECK PLANS & STATEROOMS

The deck plans are color-coded by category of stateroom, and the category letter precedes the stateroom number in each room. All staterooms are equipped with flat-panel television, DVD player, telephone and multichannel music.

Important Note: Not all staterooms within each category have the same furniture configuration and/or facilities. Appropriate symbols within the rooms on the deck plans describe differences from the stateroom descriptions below.

All information is subject to change.

STATEROOM SYMBOL LEGEND

- Triple (2 lower beds, 1 sofa bed)
- Quad (2 lower beds, 1 sofa bed, 1 upper)
- △ Partial sea view
- × Fully obstructed view
- + Connecting rooms
- ◇ These staterooms have portholes instead of windows
- ★ Suites SA030, B200 & B202 and staterooms K500, G501, G502, C563, FF829 & FF831 are modified accessible, shower only with small step, step into bathroom, standard interior and exterior door size
- ♿ Staterooms CA367, EE389, EE390, G704, G706, G709 & G711 are wheelchair accessible, roll-in shower only, wheelchair-accessible doorways

VERANDAH SPA SUITES

■ BQ

Vista Spa Suites: 2 lower beds convertible to 1 queen-size bed, whirlpool bath & shower, sitting area, private verandah, mini-bar, refrigerator, floor-to-ceiling windows. Approximately 283 sq. ft. including verandah.

VERANDAH SUITES

■ A ■ B ■ BA

Vista Suites: 2 lower beds convertible to 1 queen-size bed, whirlpool bath & shower, sitting area, private verandah, mini-bar, refrigerator, floor-to-ceiling windows. Approximately 283 sq. ft. including verandah.

OCEAN-VIEW SPA STATEROOMS

■ CQ

Large Ocean-view Spa: 2 lower beds convertible to 1 queen-size bed, bathtub & shower. Approximately 174–255 sq. ft.

INTERIOR SPA STATEROOMS

■ IQ

Large Interior Spa: 2 lower beds convertible to 1 queen-size bed, shower. Approximately 130 sq. ft.

INTERIOR STATEROOMS

■ I

Large: 2 lower beds convertible to 1 queen-size bed, shower. Approximately 182 sq. ft.

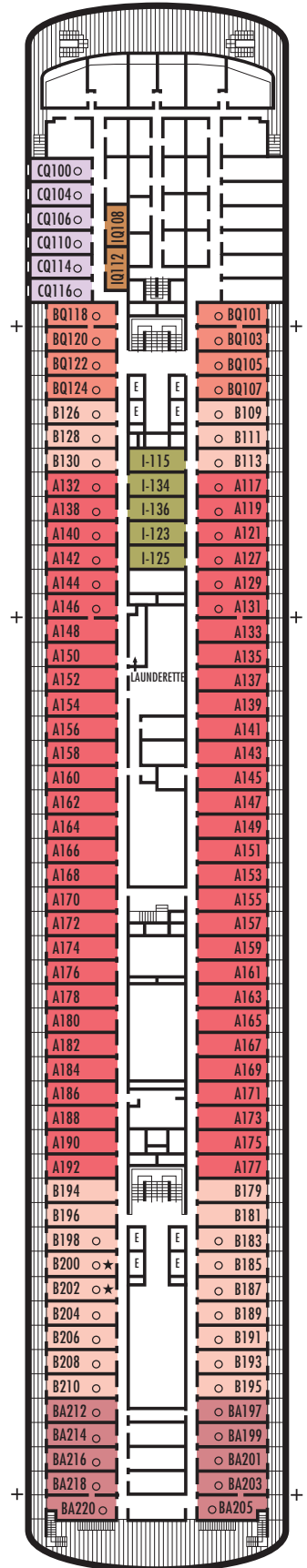
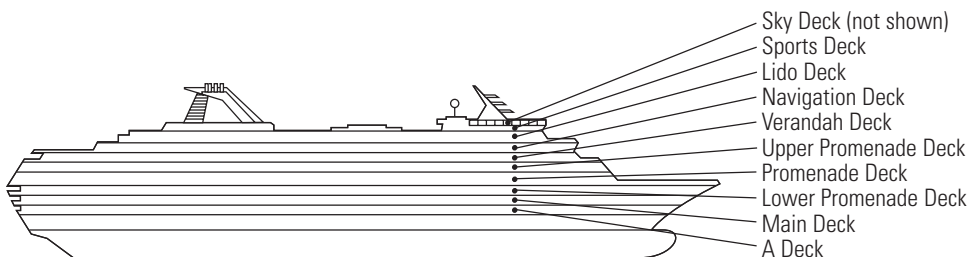

MS MAASDAM

DECK PLANS & STATEROOMS

The deck plans are color-coded by category of stateroom, and the category letter precedes the stateroom number in each room. All staterooms are equipped with flat-panel television, DVD player, telephone and multichannel music.

Important Note: Not all staterooms within each category have the same furniture configuration and/or facilities. Appropriate symbols within the rooms on the deck plans describe differences from the stateroom descriptions below.

All information is subject to change.

STATEROOM SYMBOL LEGEND

- Triple (2 lower beds, 1 sofa bed)
- Quad (2 lower beds, 1 sofa bed, 1 upper)
- △ Partial sea view
- × Fully obstructed view
- + Connecting rooms
- ◇ These staterooms have portholes instead of windows
- ★ Suites SA030, B200 & B202 and staterooms K500, G501, G502, C563, FF829 & FF831 are modified accessible, shower only with small step, step into bathroom, standard interior and exterior door size
- ♿ Staterooms CA367, EE389, EE390, G704, G706, G709 & G711 are wheelchair accessible, roll-in shower only, wheelchair-accessible doorways

VERANDAH SUITES

PS

Pinnacle Suite: Bedroom with 1 king-size bed, oversized whirlpool bath & shower, living room, dining room, dressing room, private verandah, pantry, 1 sofa bed for 2 persons, mini-bar, refrigerator, guest toilet, floor-to-ceiling windows. Approximately 1,273 sq. ft. including verandah.

SA SB

Neptune Suites: 2 lower beds convertible to 1 king-size bed, whirlpool bath & shower, large sitting area, dressing room, private verandah, 1 sofa bed for 2 persons, mini-bar, refrigerator, floor-to-ceiling windows. Approximately 575 sq. ft. including verandah.

B BB BC

Vista Suites: 2 lower beds convertible to 1 queen-size bed, whirlpool bath & shower, sitting area, private verandah, mini-bar, refrigerator, floor-to-ceiling windows. Approximately 283 sq. ft. including verandah.

INTERIOR STATEROOMS

I

Large: 2 lower beds convertible to 1 queen-size bed, shower. Approximately 141–226 sq. ft.

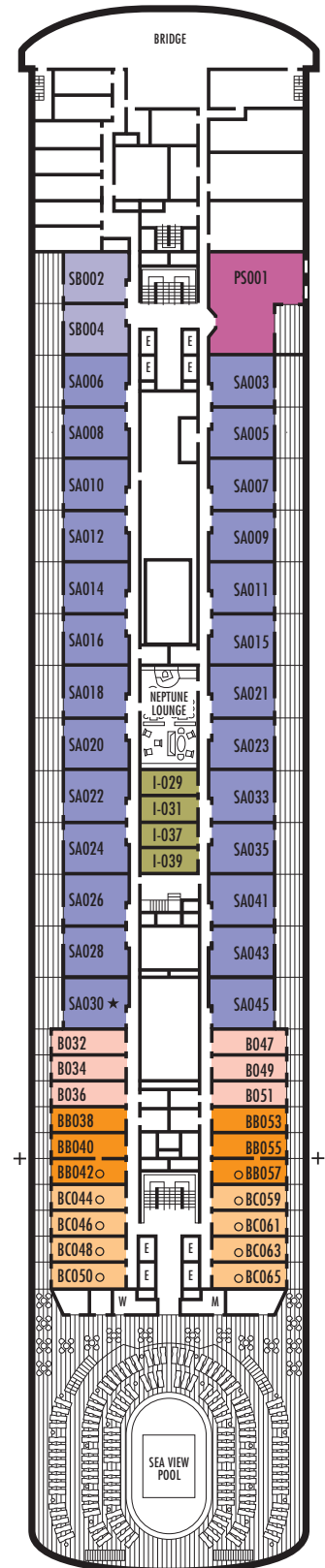
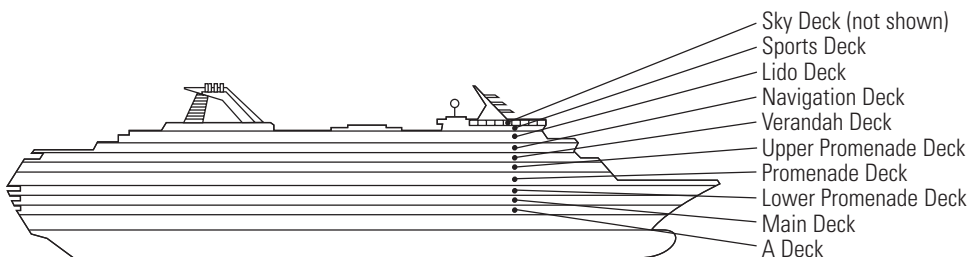

MS MAASDAM

DECK PLANS & STATEROOMS

The deck plans are color-coded by category of stateroom, and the category letter precedes the stateroom number in each room. All staterooms are equipped with flat-panel television, DVD player, telephone and multichannel music.

Important Note: Not all staterooms within each category have the same furniture configuration and/or facilities. Appropriate symbols within the rooms on the deck plans describe differences from the stateroom descriptions below.

All information is subject to change.

STATEROOM SYMBOL LEGEND

- Triple (2 lower beds, 1 sofa bed)
- Quad (2 lower beds, 1 sofa bed, 1 upper)
- △ Partial sea view
- × Fully obstructed view
- + Connecting rooms
- ◇ These staterooms have portholes instead of windows
- ★ Suites SA030, B200 & B202 and staterooms K500, G501, G502, C563, FF829 & FF831 are modified accessible, shower only with small step, step into bathroom, standard interior and exterior door size
- ♿ Staterooms CA367, EE389, EE390, G704, G706, G709 & G711 are wheelchair accessible, roll-in shower only, wheelchair-accessible doorways

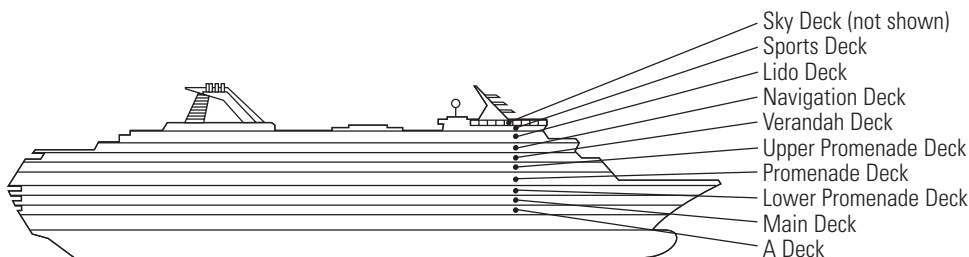
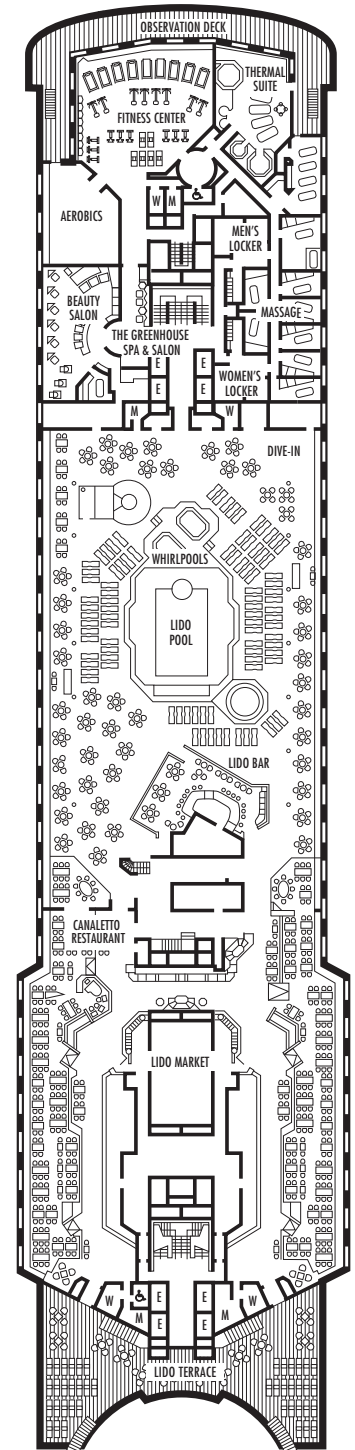

MS MAASDAM

DECK PLANS & STATEROOMS

The deck plans are color-coded by category of stateroom, and the category letter precedes the stateroom number in each room. All staterooms are equipped with flat-panel television, DVD player, telephone and multichannel music.

Important Note: Not all staterooms within each category have the same furniture configuration and/or facilities. Appropriate symbols within the rooms on the deck plans describe differences from the stateroom descriptions below.

All information is subject to change.

STATEROOM SYMBOL LEGEND

- Triple (2 lower beds, 1 sofa bed)
- Quad (2 lower beds, 1 sofa bed, 1 upper)
- △ Partial sea view
- × Fully obstructed view
- + Connecting rooms
- ◇ These staterooms have portholes instead of windows
- ★ Suites SA030, B200 & B202 and staterooms K500, G501, G502, C563, FF829 & FF831 are modified accessible, shower only with small step, step into bathroom, standard interior and exterior door size
- ♿ Staterooms CA367, EE389, EE390, G704, G706, G709 & G711 are wheelchair accessible, roll-in shower only, wheelchair-accessible doorways

